

2.krs

pohjapiirros  
3h+k 79,0m<sup>2</sup>

- A1
- A6
- A7
- A8
- A9
- A10
- A11
- A14
- A15
- A16
- B17
- B19
- B21

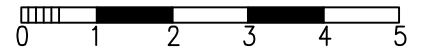

Suunnitelmiin saattaa tulla muutoksia rakennusaikana.

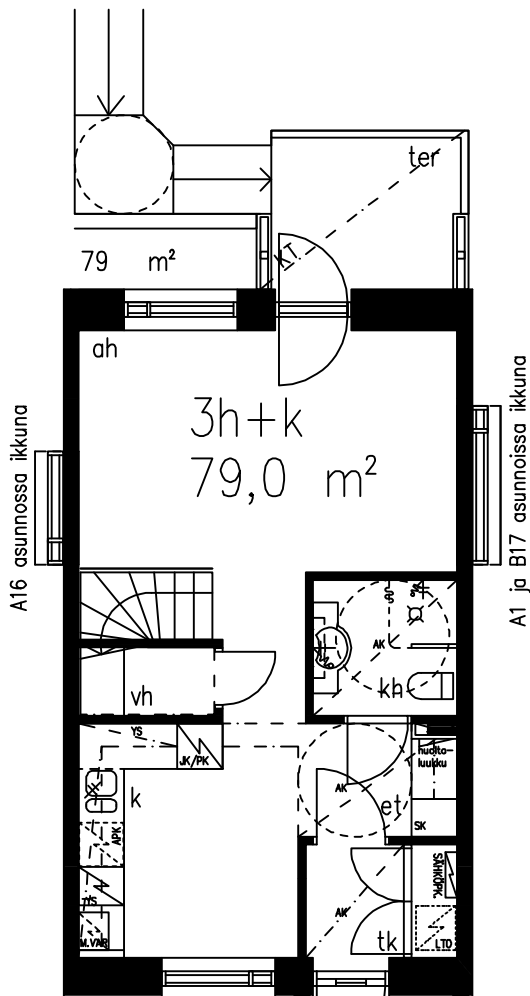

- A1
- A6-11 portaat maastomuodon mukaan
- A14-16
- B17,19,21

1.krs

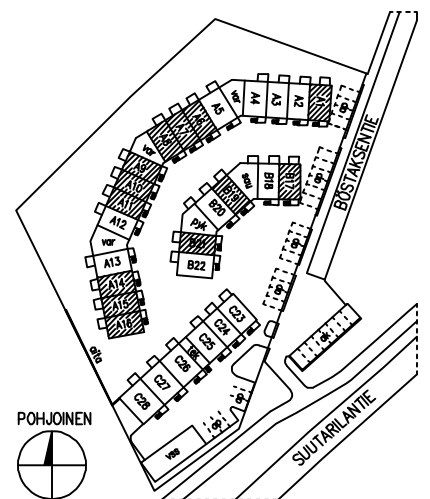

paikannuskaavio

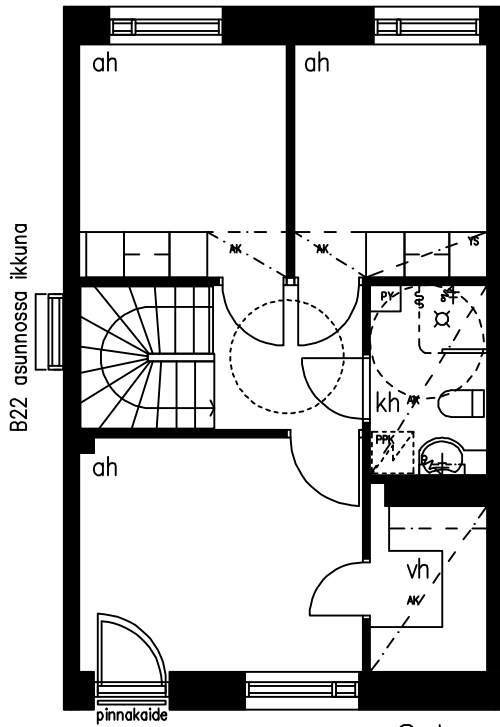

2.krs

pohjapiirros  
4h+k 85,5m<sup>2</sup>  
A2  
A3  
A4  
B18  
B20  
B22

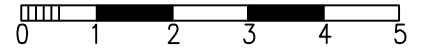

Suunnitelmiin saattaa tulla muutoksia rakennusaikana.

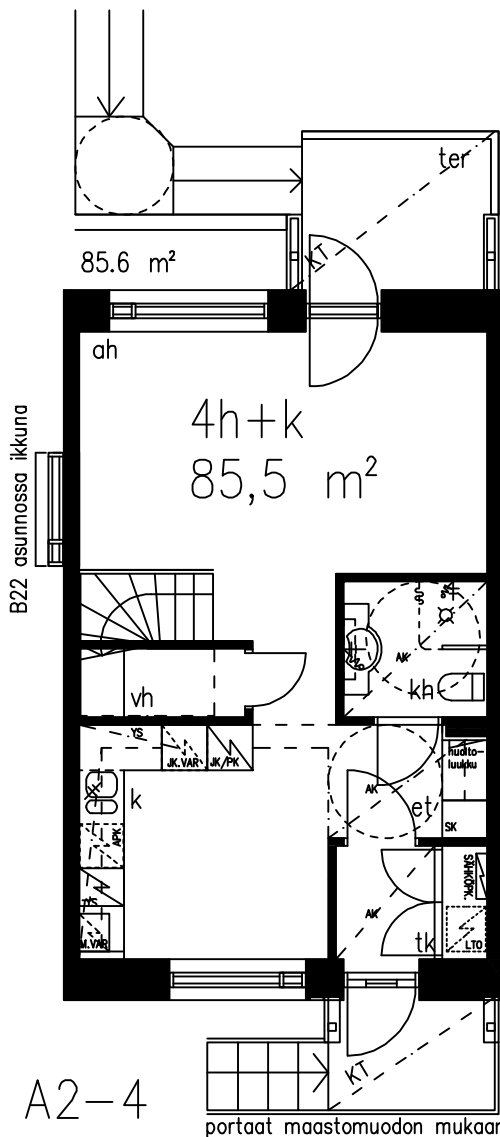

A2-4  
B18,20,22  
1.krs

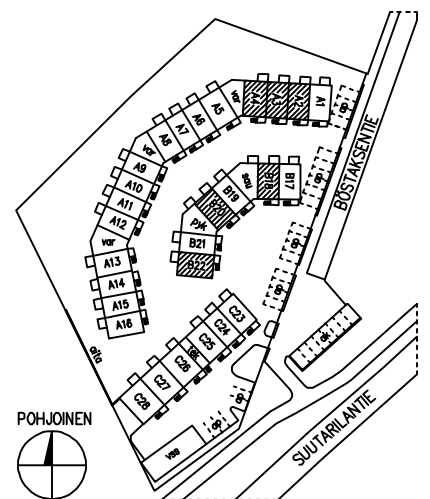

paikannuskaavio

pohjapiirros  
2h+kk 50,5m<sup>2</sup>  
A5  
A12  
A13

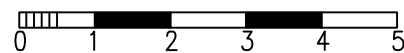

Suunnitelmiin saattaa tulla muutoksia rakennusaikana.

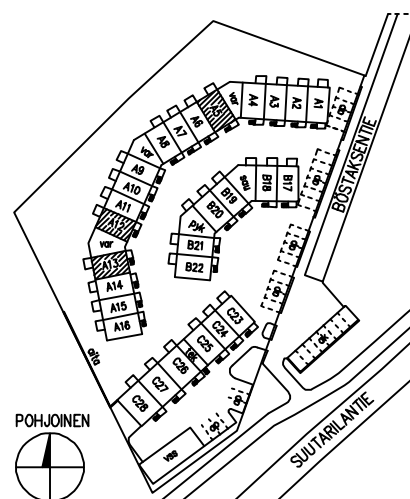
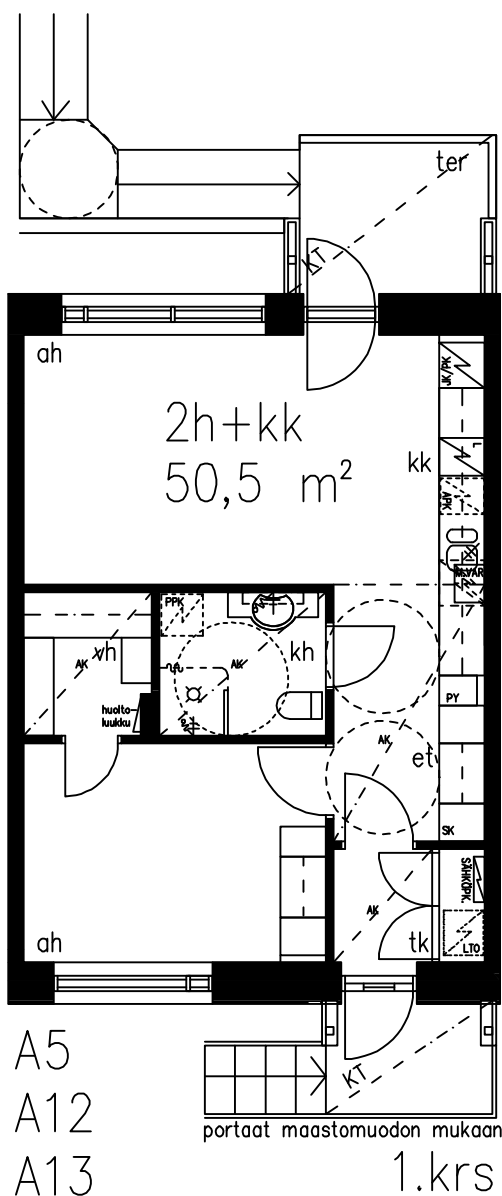

paikannuskaavio

pohjapiirros  
3h+k 80,0m<sup>2</sup>  
C23  
C24

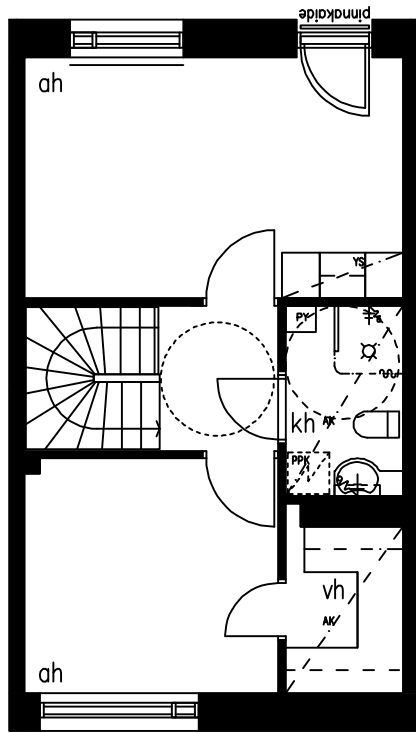

C23 asunnossa yöikkuna

2.krs

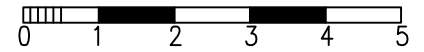

Suunnitelmiin saattaa tulla muutoksia rakennusaikana.

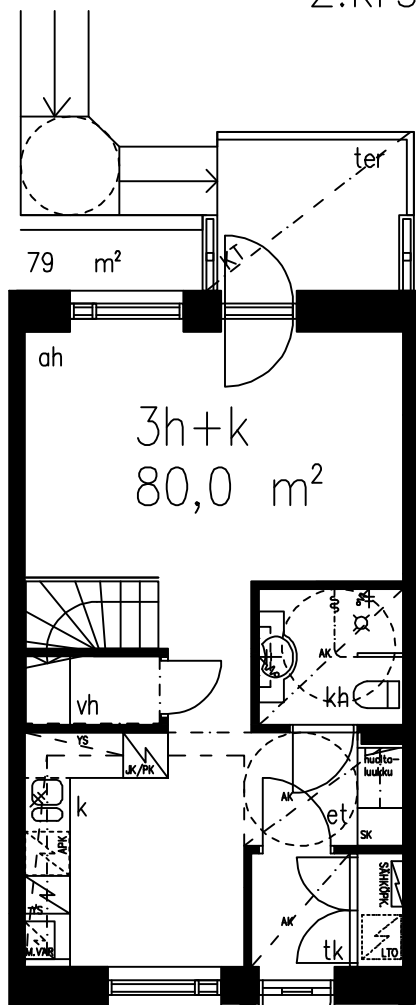

C23 asunnossa ikkuna

C23  
C24

portaat maastomuodon mukaan

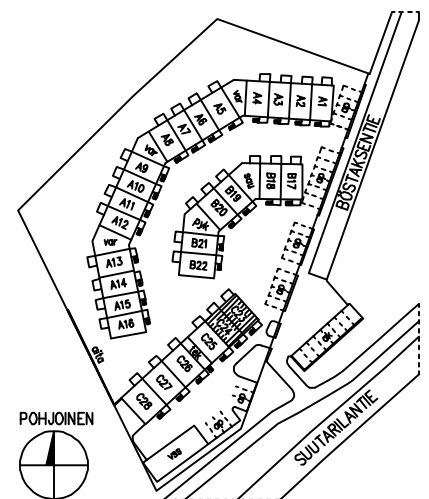

paikannuskaavio

pohjapiirros  
2h+kk 51,0m<sup>2</sup>  
C25

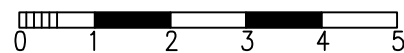

Suunnitelmiin saattaa tulla muutoksia rakennusaikana.

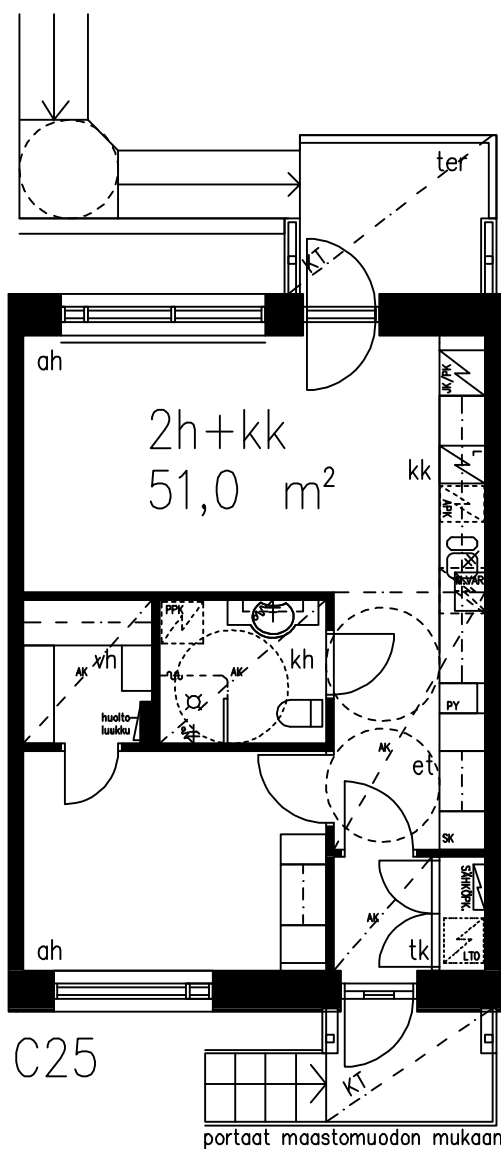

C25

1.krs

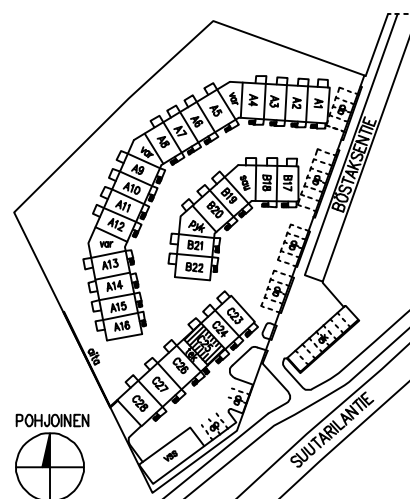

paikannuskaavio

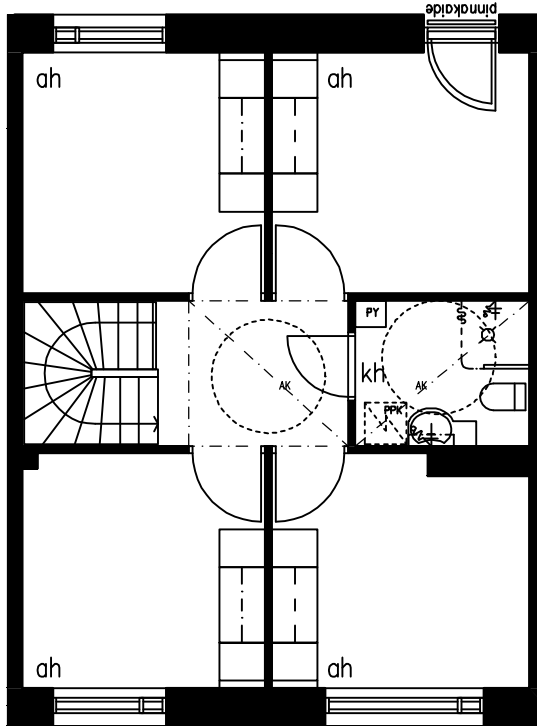

2.krs

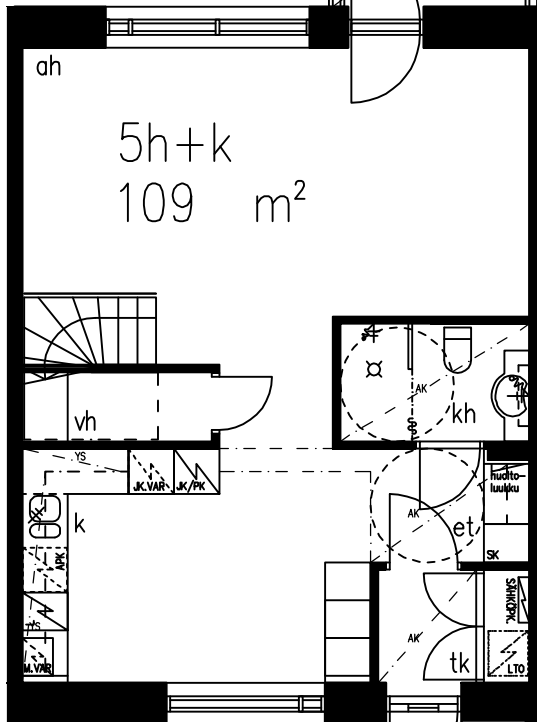
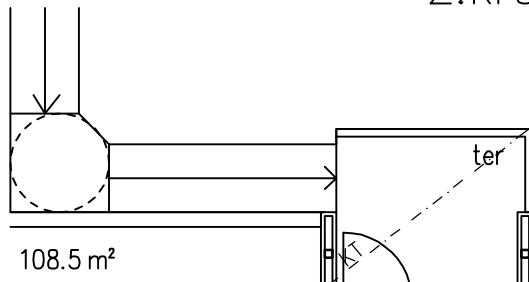

C26  
C27

portaat maastomuodon mukaan  
1.krs

pohjapiirros  
5h+k 109m<sup>2</sup>  
C26  
C27

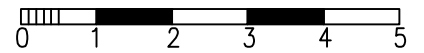

Suunnitelmiin saattaa tulla muutoksia rakennusaikana.

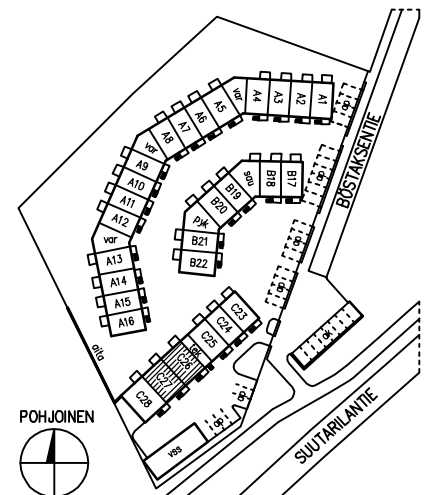

paikannuskaavio

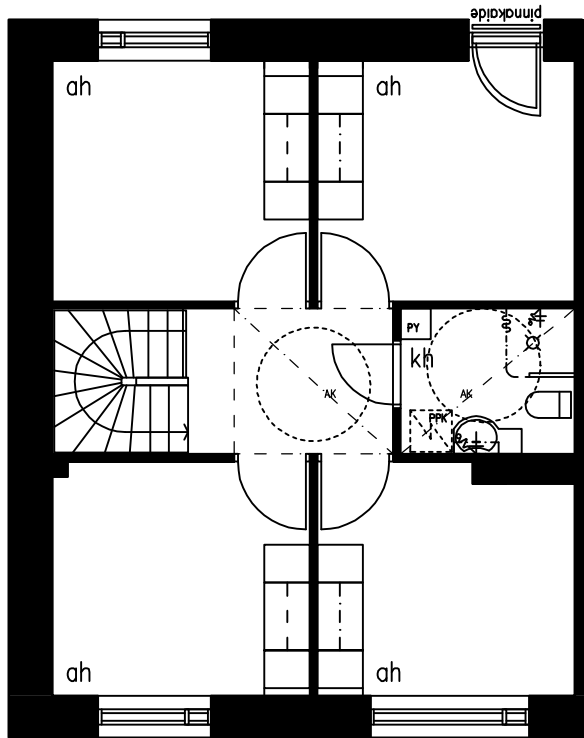

pohjapiirros  
5h+k 111,5m<sup>2</sup>  
C28

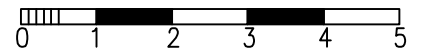

Suunnitelmiin saattaa tulla muutoksia rakennusaikana.

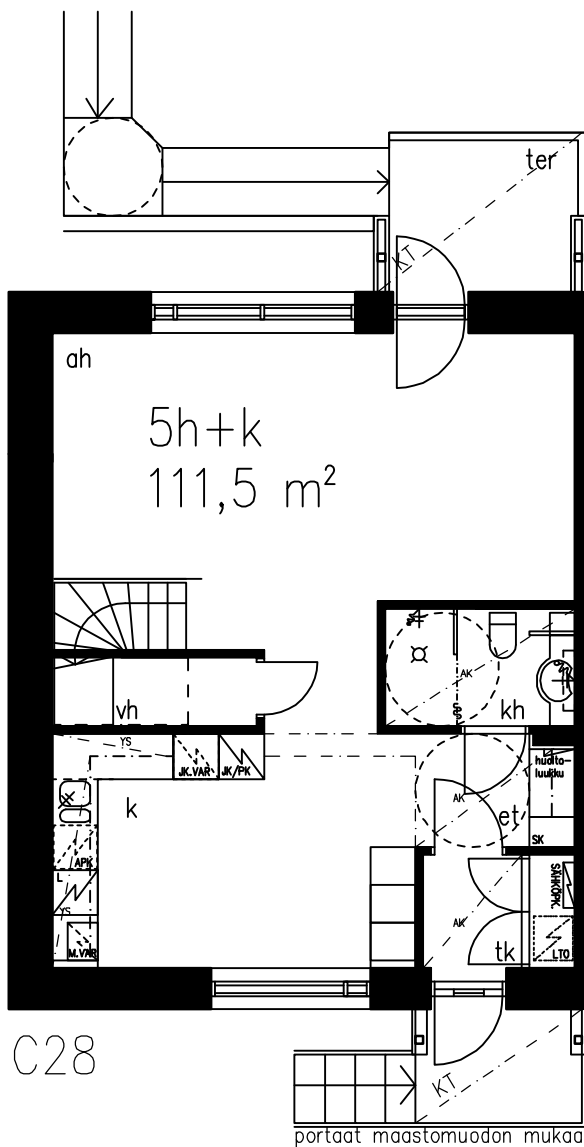

C28

portaat maastomuodon mukaan

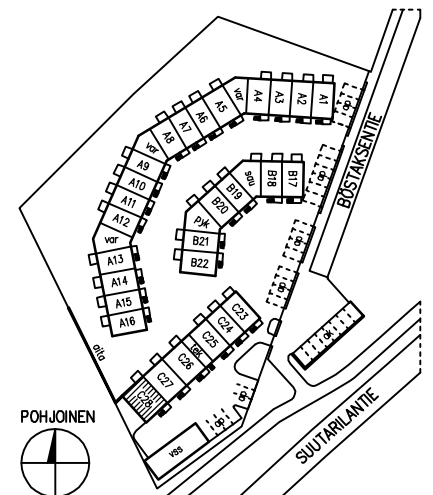

paikannuskaavio